

1

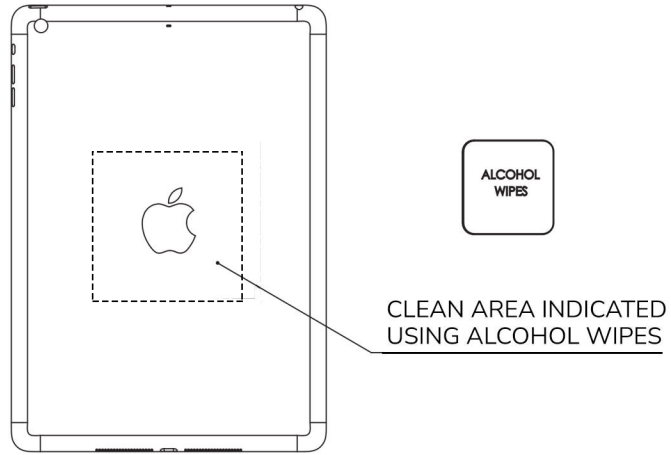

2

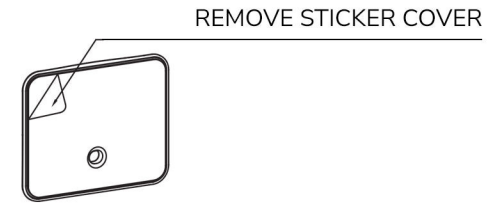

### Mounting Options

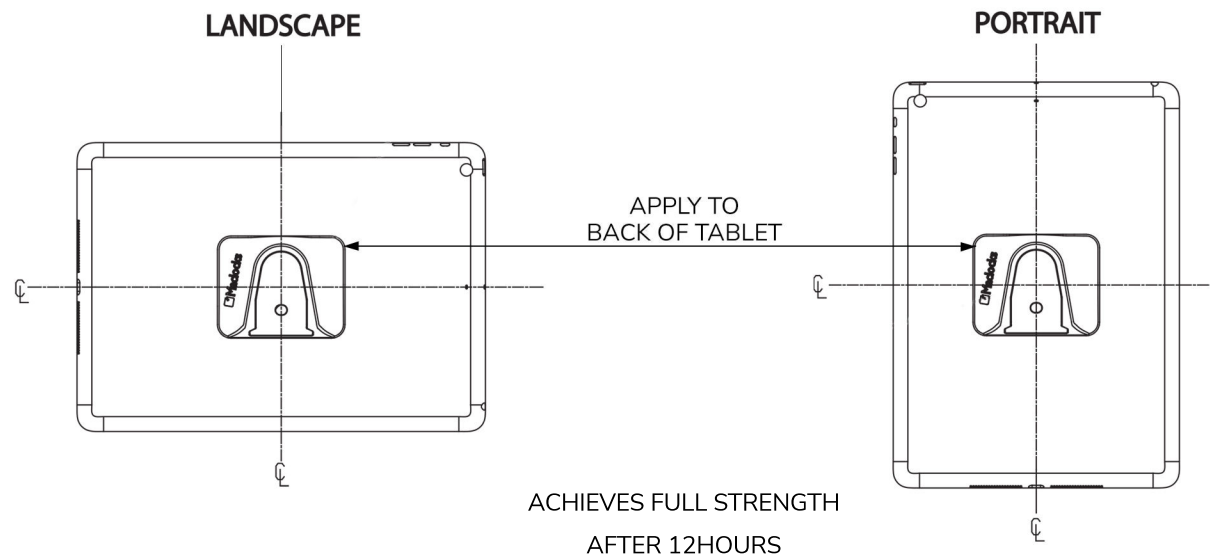

Assembly Instructions

Tablet Installation

1

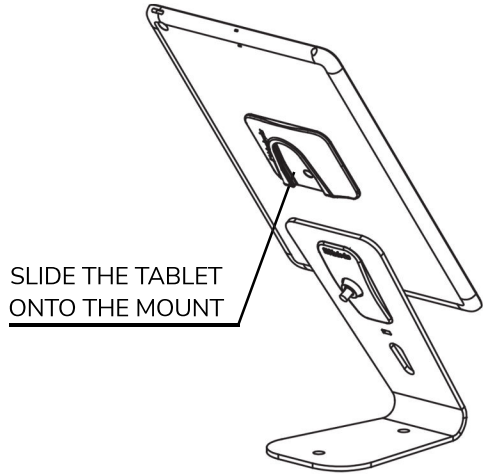

2

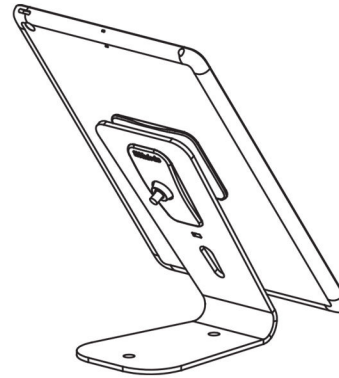

3

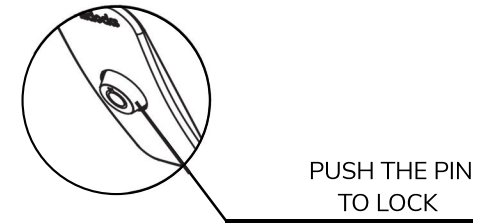

Tablet Removal

1

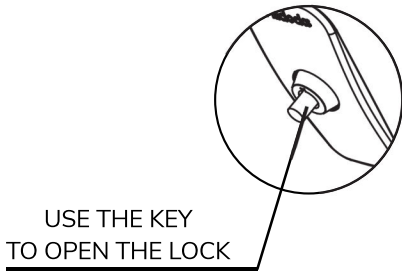

2

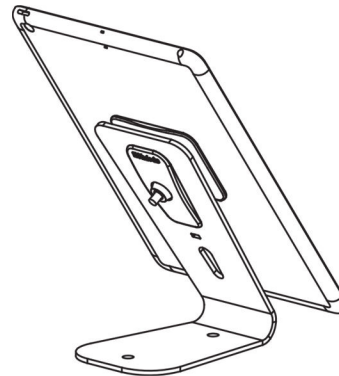

3

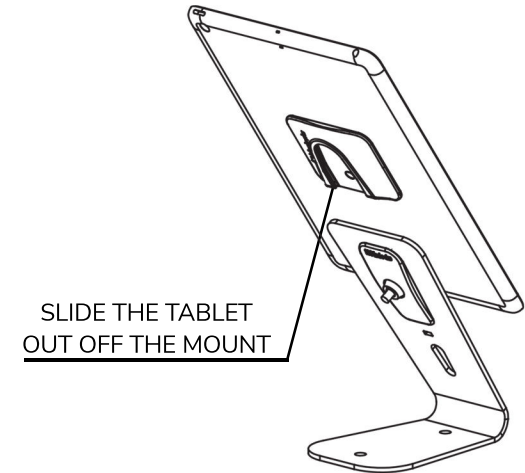

DESK MOUNTING OPTION

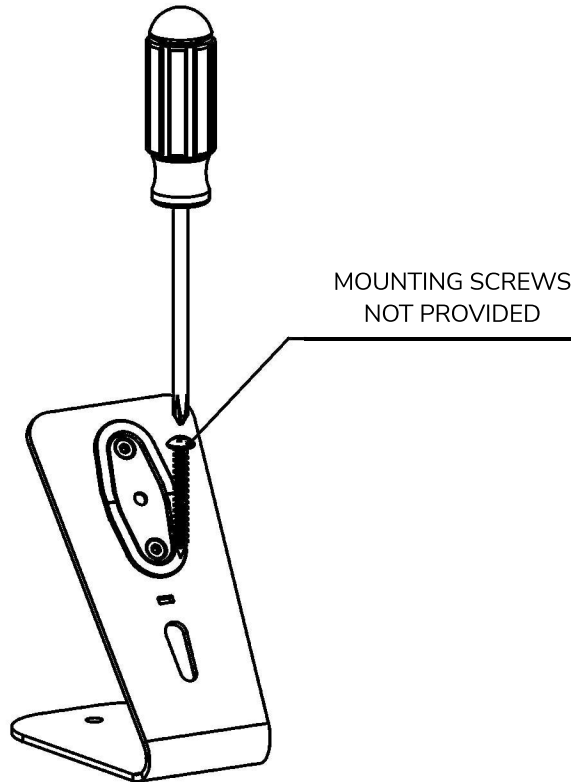

WALL MOUNTING OPTION

